

REACH & RoHS
COMPLIANT

REV.	ECN / DESCRIPTION	BY	DATE
A0	NEW	MQ.Qu	2018.03.13

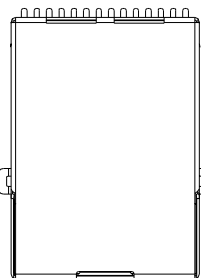

TOP VIEW

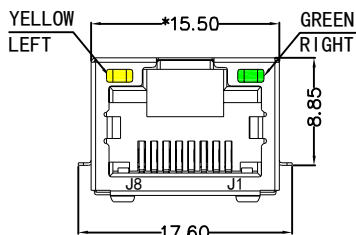

FRONT VIEW

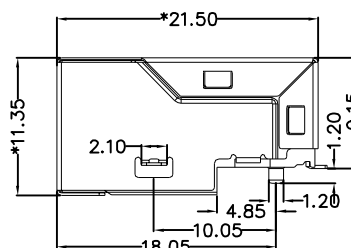

RIGHT SIDE VIEW

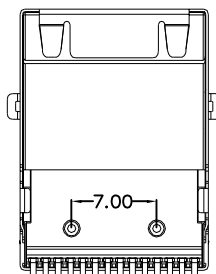

BOTTOM VIEW

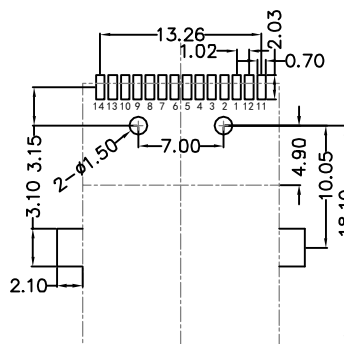

RECOMMENDED PCB LAYOUT
VIEWED FROM COMPONENT SIDE

MATERIAL:

HOUSING: LCP,UL94V-0,BLACK.
TERMINALS BRACKET: LCP,UL94V-0,BLACK.
SHIELD: C2680,T=0.20MM,NICKEL PLATING ON ALL AREA.
TERMINAL: PHOSPHOR BRONZE C5210,T=0.35MM,
6U" GOLD PLATING ON CONTACT AREA.

MECHANICAL:

DURABILITY: 750 CYCLES MIN.
MATING FORCE : 23N MAX.
OPERATING TEMPERATURE: -40°C~+85°C.
STORAGE TEMPERATURE: -40°C~+85°C.
ALL CRITICAL DIMENSIONS WITH "*"



TITLE: TAB-UP 1X1 1000BASE 贴片 (5G)	SIZE A4	UNITS MM[INCH]	GENERAL TOLERANCES UNLESS SPECIFIED		APPROVED BY: JP.Gong
PART NO.: SYT211Q138AB1A7CBS5 (5G)	SACLE 1:1	REV A0	x±0.35	x°±3.0°	CHECKED BY: TW.Xu
REMARK:	SHEET 1/3		.xx±0.25	.xx°±1.5°	DESIGND BY: ZG.Hu
			.xxx±0.10	.xxx°±1.0°	

REACH & RoHS
COMPLIANT

REV.	ECN / DESCRIPTION	BY	DATE
A0	NEW	MQ.Qu	2018.03.13

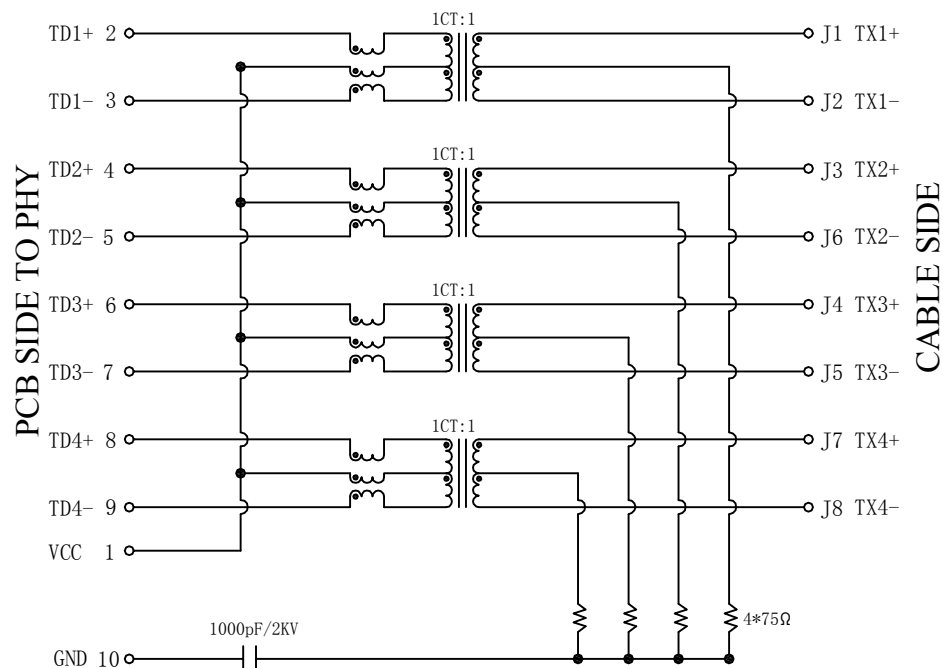

Electrical:

- Turn ratio: 2~3: J1~J2=1CT:1CT(±2%).
4~5: J3~J6=1CT:1CT(±2%).
6~7: J1~J2=1CT:1CT(±2%).
8~9: J3~J6=1CT:1CT(±2%).
- OCL: 120uH Min. @ 100KHz 0.1V.
- Insertion Loss: -0.5 dB Min. 1~50MHz.
-1.2 dB Min. 50~125MHz.
-2 dB Min. 125~250MHz.
- Return loss: -16dB Min 1~40MHz;
16+10LOG10(f/40) 40<f≤250dB 40~250MHz.
- CMR: -30dB Min 1~40MHz;
-28dB Min 40~100MHz;
-26dB Min 100~500MHz;
- Common talk: -30dB Min 1~250MHz;
- 100% of production tested to comply with
IEEE 802.3 isolation requirements balanced DC
line current 720mA max. @57V DC continuous.
- Input-output isolation :2250V DC Minmum for 60S

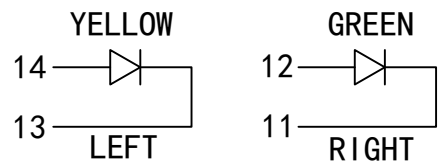

LED Specification

Standard LED Color	LED Wavelength	Foward(A)	Foward(V)
Green	568nm	20mA	1.85-2.45V
Yellow	585nm	20mA	1.7-2.2V

WOHU 苏州沃虎电子科技有限公司
Su Zhou Wo Hu Electronic Tech.Co.,Ltd.

TITLE: TAB-UP 1X1 1000BASE 贴片 (5G)	SIZE A4	UNITS MM[INCH]	GENERAL TOLERANCES UNLESS SPECIFIED		APPROVED BY: JP.Gong
PART NO.: SYT211Q138AB1A7CBS5 (5G)	SACLE 1:1	REV A0	x±0.35	x°±3.0°	CHECKED BY: TW.Xu
REMARK:	SHEET 2/3		.xx±0.25	.xx°±1.5°	DESIGND BY: ZG.Hu
			.xxx±0.10	.xxx°±1.0°	

REACH & RoHS
COMPLIANT

REV.	ECN / DESCRIPTION	BY	DATE
A0	NEW	MQ.Qu	2018.03.13

PROFILE OF REFLOW SOLDERING

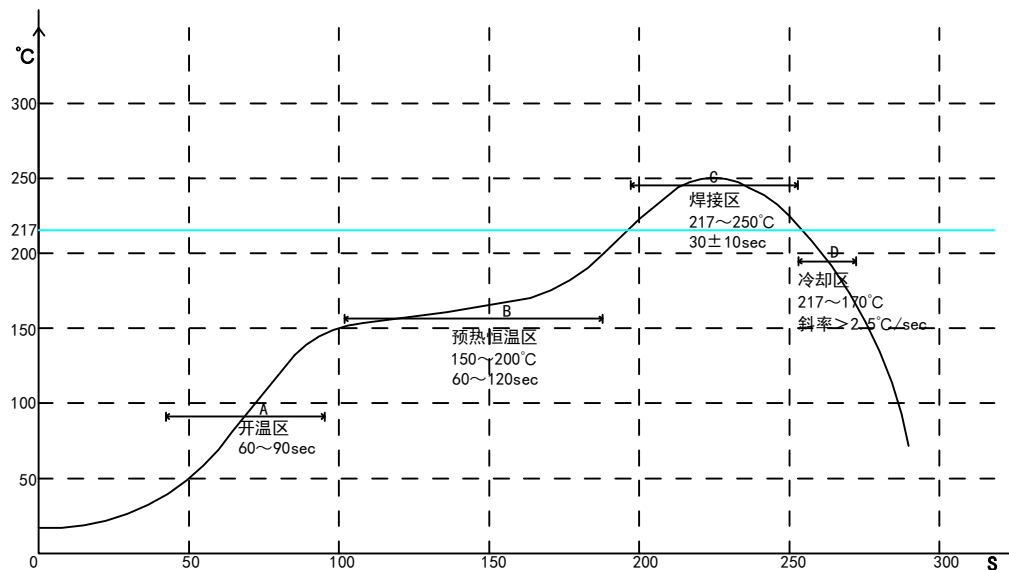

A. Temperature range of open
 B. Preheat temperature zone
 C. The welding zone
 D. The cooling zone
 Tip temperature: 265±5°C.
 Tip temperature time: 30±10Sec.
 Tip melting point of Sn96.5/Ag3/Cu0.5.

WOHU 苏州沃虎电子科技有限公司
 Su Zhou Wo Hu Electronic Tech.Co.,Ltd.

TITLE: TAB-UP 1X1 1000BASE 贴片 (5G)	SIZE A4	UNITS MM[INCH]	GENERAL TOLERANCES UNLESS SPECIFIED		APPROVED BY: JP.Gong
PART NO.: SYT211Q138AB1A7CBS5 (5G)	SACLE 1:1	REV A0	x±0.35	x°±3.0°	CHECKED BY: TW.Xu
REMARK:	SHEET 3/3		.x±0.30	.x°±2.0°	DESIGND BY: ZG.Hu
			.xx±0.25	.xx°±1.5°	
			.xxx±0.10	.xxx°±1.0°	