

REV. 版本	ECN NO. 变更说明	DATE 日期
A-D	见老版图纸	
E	修改图纸	2017.08.08
F	调整图纸	2018.12.20
G	调整标注	2023.02.08

SC02

NOTE:
MATERIAL:

- CONTACT: PHOSPHOR BRONZE.
- CONNECTOR HOUSING: LCP UL 94V-0. COLOR: BLACK.
- MOULDED INSERT: HIGH TEMPERATURE PLASTIC UL 94V-0. COLOR:BLACK.
- CAGE: COPPER ALLOY.
- LIGHT PIPES: POLYCARBONATE. UL 94V-0. COLOR:CLEAR
- LIGHT PIPE HOUSING: PBT UL 94V-0 COLOR:BLACK.

PLATED:

- CONTACT MATING AREA : PLATING GOLD OVER 1.27 MICROMETERS MINIMUM

NICKEL:

- CONTACT NEEDLE EYE: 2.54 MICROMETERS MINIMUM MATTE TIN OVER 1.27 MICROMETERS MINIMUM NICKEL.

MECHANICAL REQUIREMENT:

- DURABILITY: 100 CYCLES MIN.
- INSERTION AND EXTRACTION FORCE: 40N MAX & 11.5N MAX

ENVIRONMENTAL:

- LOW LEVEL CONTACT RESITANCE(LLCR):
ΔR 10 MILLIOHMS MAXIMUM FOR SHIELD AND SIGNAL CONTACTS.
- DIELECTRIC WITHSTANDING VOLTAGE: 300V AC/MAX.
- INSULATION RESISTANCE: 1×10^9 OHMS MINIMUM.
- RATINGS CURRENT: 0.5 AMPS MAX.
- RATINGS VOLTAGE: 30 VOLTS DC/AC(RMS) MAX.
- OPERATION: $-40^{\circ}\text{C} \sim +85^{\circ}\text{C}$.
- STORAGE: $-55^{\circ}\text{C} \sim +105^{\circ}\text{C}$.
- ROHS COMPLIANT

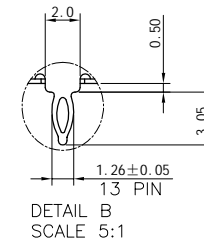
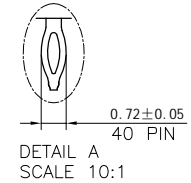
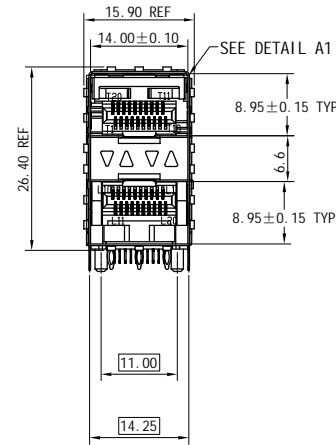
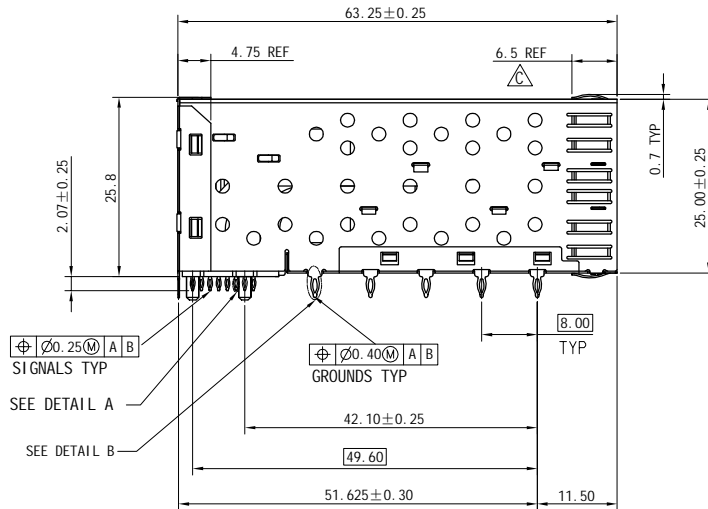
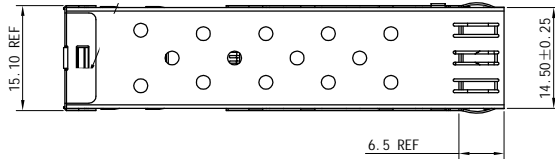

RoHS Compliant

WOHU 苏州沃虎电子科技有限公司
Tel:4001048018 http://www.wohu-tek.com

TOLERANCES 公差
.X ±0.25
.XX ±0.13
.XXX ±0.10
ANGLES: ±2°

Material: 材质
SEE NOTE
Finish: 电镀
SEE NOTE

Designed: 设计
Lamei Tang
Checked: 审核
Qi anpu Zhao
Approved: 核准
Robi n
SHEET 1 OF 5
第 页 共 页

NAME: 名称
SFP 2X1 CONNECTOR
DWG NO: 图号
ESFP11062701-C
PART NO: 料号
SEE TABLE

REV. 版本
G

第三视角
A4
SIZE

SCALE 比例
2:1

UNIT 单位
mm

CUSTOMER: 客户
MODEL NO: 模号

N/A
N/A

REV. 版本	ECN NO. 变更说明	DATE 日期

SC02

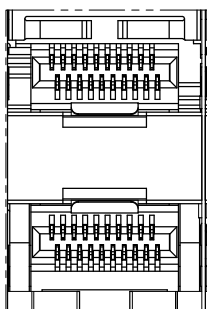

TYPE1_NONE LIGHT PIPES

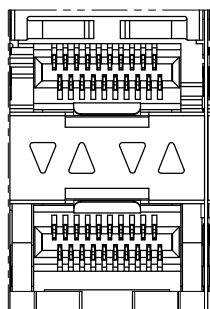

TYPE2_4 LIGHT PIPES

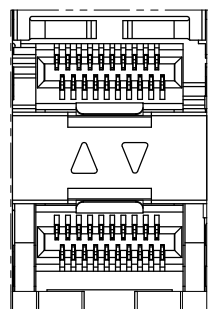

TYPE1_3 INNER LIGHT PIPES

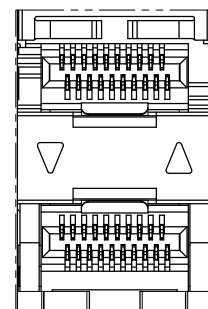

TYPE4_2 OUTER LIGHT PIPES

LIGHT PIPE CONFIGURATION
DETAIL D SCALE 2:1

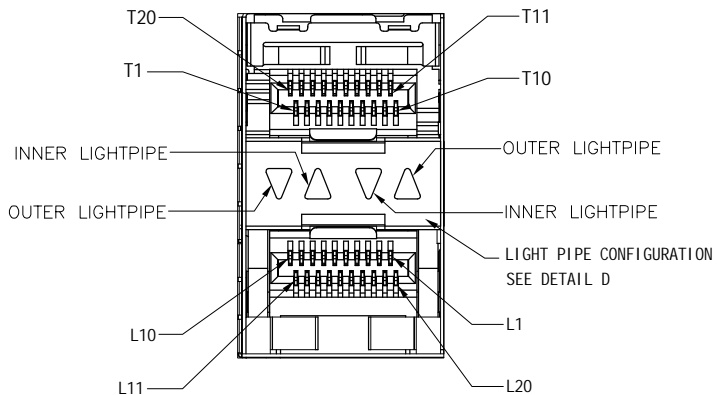

DETAIL A1
SCALE 4:1

RoHS Compliant

WOHU 苏州沃虎电子科技有限公司
Tel:4001048018 http://www.wohu-tek.com

TOLERANCES 公差
.X ±0.25
.XX ±0.13
.XXX ±0.10
ANGLES: ±2°

Material: 材质
SEE NOTE
Finish: 电镀
SEE NOTE

SHEET 2 OF 5
第 页 共 页

Designed: 设计
Lamei Tang
Checked: 审核
Qi anpu Zhao
Approved: 核准
Robi n

NAME: 名称
SFP 2X1 CONNECTOR
DWG NO: 图号
ESFP11062701-C
PART NO: 料号
SEE TABLE

REV. 版本
G

REV. 版本
G

第三视角

A4
SIZE

SCALE 比例
2:1

UNIT 单位
mm

CUSTOMER: 客户
MODEL NO: 模号
N/A

REV. 版本	ECN NO. 变更说明	DATE 日期

SC02

10705221D021	B869S-0015-Y021	SFP 2X1 PRESS FIT CONNECTOR	WITH INNER/OUTER LIGHT PIPES	▽△▽△	15u"	WITHOUT LOGO	UNPLATED
10705121D003	B869S-0015-Y008	SFP 2X1 PRESS FIT CONNECTOR	WITHOUT LIGHT PIPES		15u"	WITHOUT LOGO	UNPLATED
10705221D034	B869S-0015-Y048	SFP 2X1 PRESS FIT CONNECTOR	WITH OUTER LIGHT PIPES	▽△	15u"	WITHOUT LOGO	UNPLATED
10705221D035	B869S-0015-Y049	SFP 2X1 PRESS FIT CONNECTOR	WITH INNER LIGHT PIPES	△▽	15u"	WITHOUT LOGO	UNPLATED
10705221F006		SFP 2X1 PRESS FIT CONNECTOR	WITH INNER/OUTER LIGHT PIPES	▽△▽△	30u"	WITHOUT LOGO	UNPLATED
10705121F006		SFP 2X1 PRESS FIT CONNECTOR	WITHOUT LIGHT PIPES		30u"	WITHOUT LOGO	UNPLATED
10705221F019		SFP 2X1 PRESS FIT CONNECTOR	WITH OUTER LIGHT PIPES	▽△	30u"	WITHOUT LOGO	UNPLATED
10705221F020		SFP 2X1 PRESS FIT CONNECTOR	WITH INNER LIGHT PIPES	△▽	30u"	WITHOUT LOGO	UNPLATED
10705221D045		SFP 2X1 PRESS FIT CONNECTOR	WITH INNER/OUTER LIGHT PIPES	▽△▽△	15u"	WITHOUT LOGO	Ni 30u"MIN
10705121D024		SFP 2X1 PRESS FIT CONNECTOR	WITHOUT LIGHT PIPES		15u"	WITHOUT LOGO	Ni 30u"MIN
10705221D046		SFP 2X1 PRESS FIT CONNECTOR	WITH OUTER LIGHT PIPES	▽△	15u"	WITHOUT LOGO	Ni 30u"MIN
10705221D044		SFP 2X1 PRESS FIT CONNECTOR	WITH INNER LIGHT PIPES	△▽	15u"	WITHOUT LOGO	Ni 30u"MIN
10705221F014		SFP 2X1 PRESS FIT CONNECTOR	WITH INNER/OUTER LIGHT PIPES	▽△▽△	30u"	WITHOUT LOGO	Ni 30u"MIN
10705121F011		SFP 2X1 PRESS FIT CONNECTOR	WITHOUT LIGHT PIPES		30u"	WITHOUT LOGO	Ni 30u"MIN
10705221F015		SFP 2X1 PRESS FIT CONNECTOR	WITH OUTER LIGHT PIPES	▽△	30u"	WITHOUT LOGO	Ni 30u"MIN
10705221F016		SFP 2X1 PRESS FIT CONNECTOR	WITH INNER LIGHT PIPES	△▽	30u"	WITHOUT LOGO	Ni 30u"MIN
10705221D014	B869S-0015-Y031	SFP 2X1 PRESS FIT CONNECTOR	WITH INNER/OUTER LIGHT PIPES	▽△▽△	15u"	WITH LOGO	UNPLATED
10705121D006	B869S-0015-Y032	SFP 2X1 PRESS FIT CONNECTOR	WITHOUT LIGHT PIPES		15u"	WITH LOGO	UNPLATED
10705221D013	B869S-0015-Y033	SFP 2X1 PRESS FIT CONNECTOR	WITH OUTER LIGHT PIPES	▽△	15u"	WITH LOGO	UNPLATED
10705221D033	B869S-0015-Y034	SFP 2X1 PRESS FIT CONNECTOR	WITH INNER LIGHT PIPES	△▽	15u"	WITH LOGO	UNPLATED
10705221F005		SFP 2X1 PRESS FIT CONNECTOR	WITH INNER/OUTER LIGHT PIPES	▽△▽△	30u"	WITH LOGO	UNPLATED
10705121F001	B869S-0030-Y002	SFP 2X1 PRESS FIT CONNECTOR	WITHOUT LIGHT PIPES		30u"	WITH LOGO	UNPLATED
10705221F017		SFP 2X1 PRESS FIT CONNECTOR	WITH OUTER LIGHT PIPES	▽△	30u"	WITH LOGO	UNPLATED
10705221F018		SFP 2X1 PRESS FIT CONNECTOR	WITH INNER LIGHT PIPES	△▽	30u"	WITH LOGO	UNPLATED
10705221D016	B869S-0015-Y016	SFP 2X1 PRESS FIT CONNECTOR	WITH INNER/OUTER LIGHT PIPES	▽△▽△	15u"	WITH LOGO	Ni 30u"MIN
10705121D004	B869S-0015-Y015	SFP 2X1 PRESS FIT CONNECTOR	WITHOUT LIGHT PIPES		15u"	WITH LOGO	Ni 30u"MIN
10705221D030		SFP 2X1 PRESS FIT CONNECTOR	WITH OUTER LIGHT PIPES	▽△	15u"	WITH LOGO	Ni 30u"MIN
10705221D029		SFP 2X1 PRESS FIT CONNECTOR	WITH INNER LIGHT PIPES	△▽	15u"	WITH LOGO	Ni 30u"MIN
10705221F011	B869S-0030-Y032	SFP 2X1 PRESS FIT CONNECTOR	WITH INNER/OUTER LIGHT PIPES	▽△▽△	30u"	WITH LOGO	Ni 30u"MIN
10705121F002	B869S-0030-Y033	SFP 2X1 PRESS FIT CONNECTOR	WITHOUT LIGHT PIPES		30u"	WITH LOGO	Ni 30u"MIN
10705221F012	B869S-0030-Y034	SFP 2X1 PRESS FIT CONNECTOR	WITH OUTER LIGHT PIPES	▽△	30u"	WITH LOGO	Ni 30u"MIN
10705221F013	B869S-0030-Y035	SFP 2X1 PRESS FIT CONNECTOR	WITH INNER LIGHT PIPES	△▽	30u"	WITH LOGO	Ni 30u"MIN

RoHS Compliant

WOHU 苏州沃虎电子科技有限公司
 Tel:4001048018 http://www.wohu-tek.com

第三视角

A4
 SIZE

SCALE 比例 2:1
 UNIT 单位 mm

CUSTOMER: 客户 N/A
 MODEL NO: 模号 N/A

TOLERANCES 公差
 .X ±0.25
 .XX ±0.13
 .XXX ±0.10
 ANGLES: ±2°

Material: 材质
 Finish: 电镀
 SHEET 3 OF 5
 第 3 页 共 5 页

SEE NOTE
 SEE NOTE

Designed: 设计
 Checked: 审核
 Approved: 核准

Lamei Tang
 Qi anpu Zhao
 Robi n

NAME: 名称
 DWG NO: 图号
 PART NO: 料号

SFP 2X1 CONNECTOR
 ESFP11062701-C
 SEE TABLE

REV. 版本
 G

REV. 版本	ECN NO. 变更说明	DATE 日期

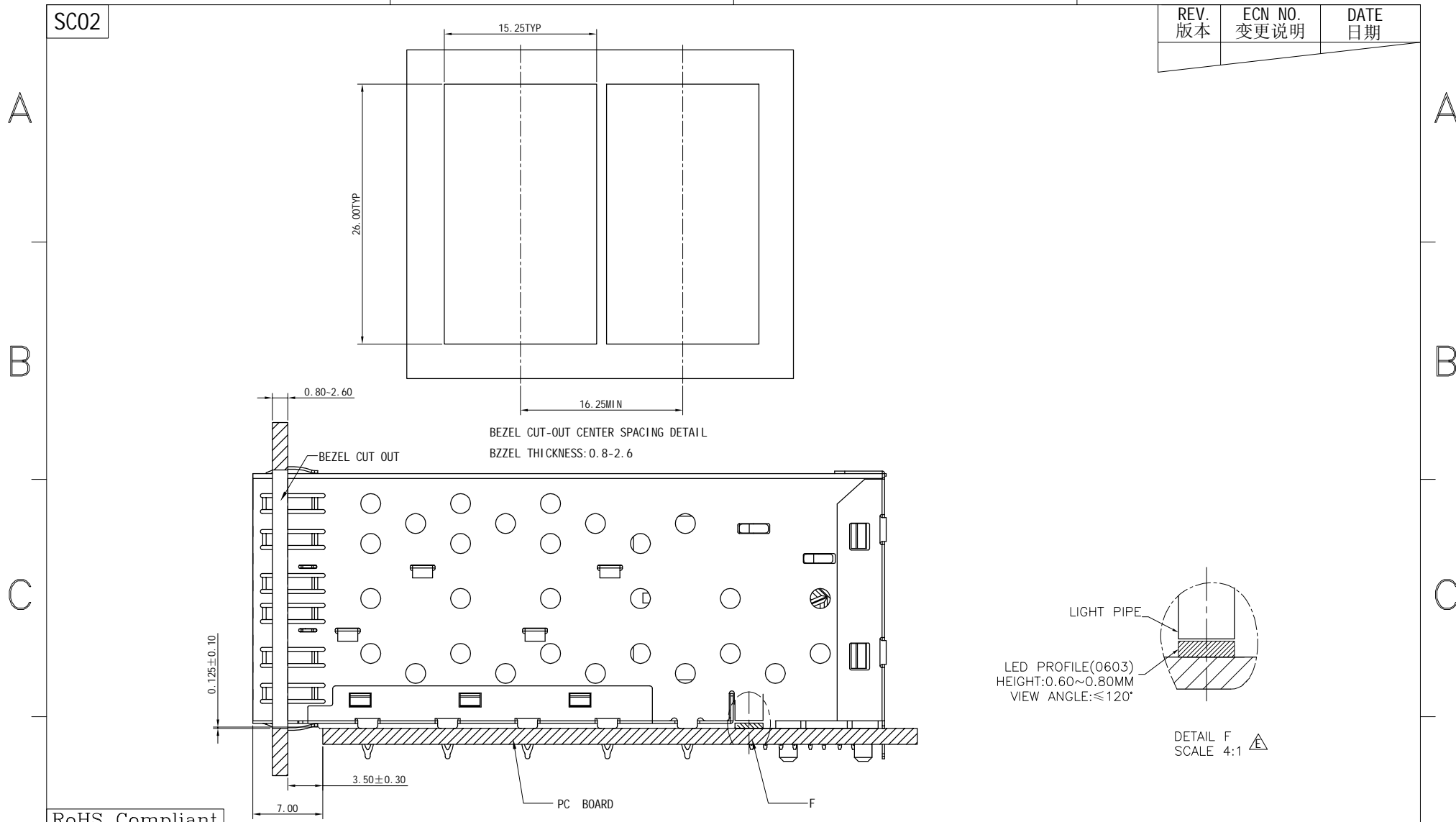

RoHS Compliant

WOHU 苏州沃虎电子科技有限公司
 Tel:4001048018 http://www.wohu-tek.com

第三视角	A4 SIZE	SCALE 比例	UNIT 单位	CUSTOMER: 客户	N/A
		2:1	mm	MODEL NO: 模号	N/A

TOLERANCES 公差
 .X ±0.25
 .XX ±0.13
 .XXX ±0.10
 ANGLES: ±2°

Material: 材质 SEE NOTE
 Finish: 电镀 SEE NOTE
 SHEET 4 OF 5
 第 4 页 共 5 页

Designed: 设计
 Checked: 审核
 Approved: 核准

Lamei Tang
 Qi anpu Zhao
 Robi n

NAME: 名称	SFP 2X1 CONNECTOR	
DWG NO: 图号	ESFP11062701-C	REV. 版本
PART NO: 料号	SEE TABLE	G

REV. 版本	ECN NO. 变更说明	DATE 日期

SC02

A

A

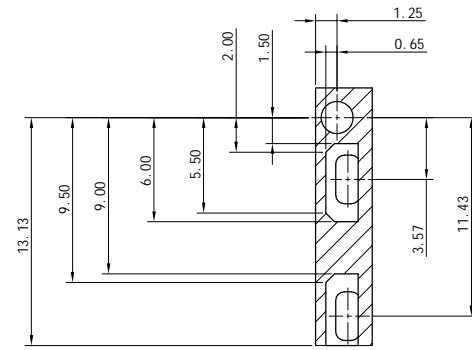
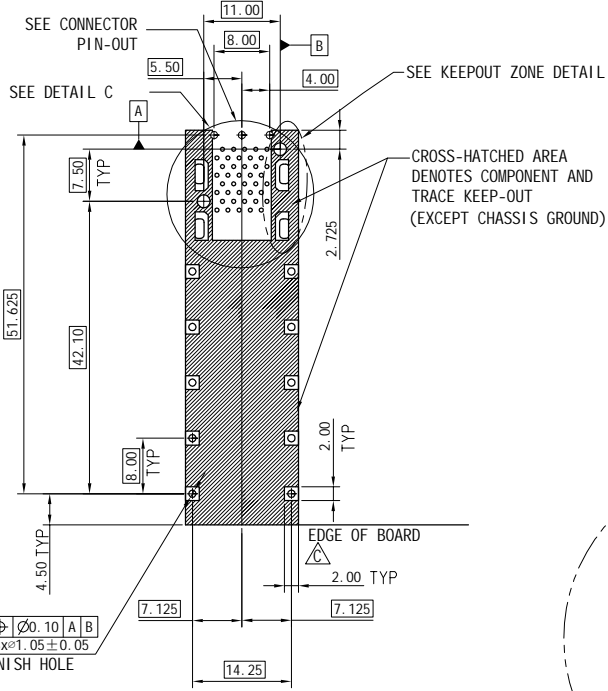

KEEPOUT ZONE
DETAIL SCALE 5:1

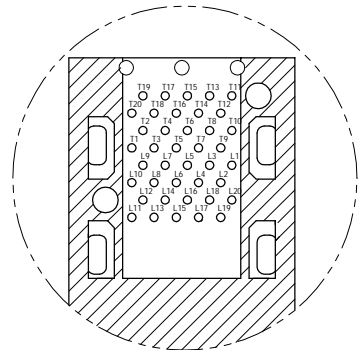

CONNECTOR PIN-OUT
COMPONENT SIDE OF BOARD

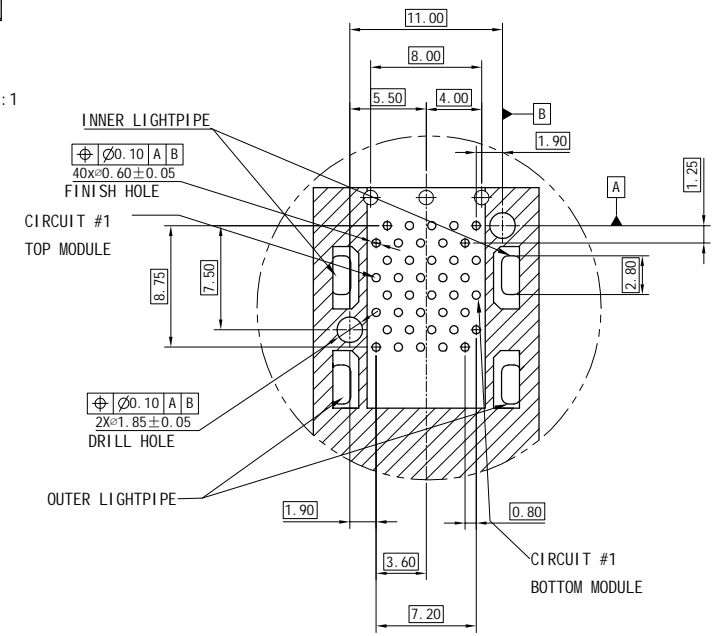

DETAIL C
SCALE 5:1

B

B

C

C

RECOMMENDED PCB LAYOUT-COMPONENT SIDE
RECOMMENDED PCB THICKNESS-2.63MM

THE ENTIRE AREA OF THE CONNECTOR FOOTPRINT
TO BE CONSIDERED THE KEEP OUT AREA FOR COMPONENTS
(OTHER THAN LIGHT PIPE LED'S)
THIS AREA IS INDICATED BY THE DASHED LINE

RoHS Compliant

D

D

WOHU 苏州沃虎电子科技有限公司
Tel:4001048018 http://www.wohu-tek.com

第三视角	A4 SIZE	SCALE 比例 2:1	UNIT 单位 mm	CUSTOMER: 客户 MODEL NO: 模号	N/A N/A
------	------------	--------------------	------------------	------------------------------------	------------

TOLERANCES
公差

.X	±0.25
.XX	±0.13
.XXX	±0.10

ANGLES: ±2°

Material: 材质	SEE NOTE
Finish: 电镀	SEE NOTE
SHEET 5 OF 5 第 5 页 共 5 页	

Designed: 设计	Lamei Tang
Checked: 审核	Qi anpu Zhao
Approved: 核准	Robi n

NAME: 名称	SFP 2X1 CONNECTOR
DWG NO: 图号	ESFP11062701-C
PART NO: 料号	SEE TABLE

REV. 版本	G
------------	---