

REACH & RoHS  
COMPLIANT

REV.	ECN / DESCRIPTION	BY	DATE
A0	NEW	ZG.Hu	2018.03.19

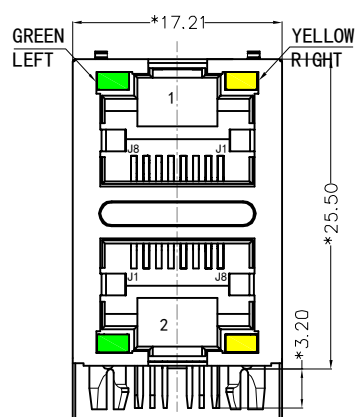

FRONT VIEW

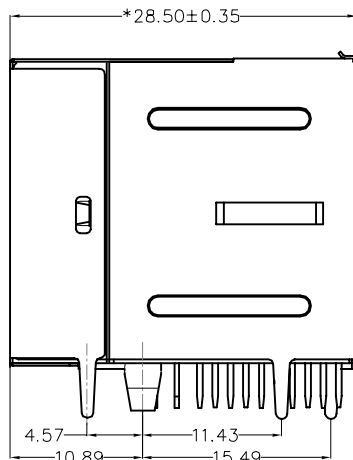

RIGHT SIDE VIEW

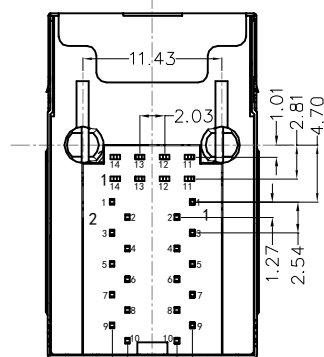

BOTTOM VIEW

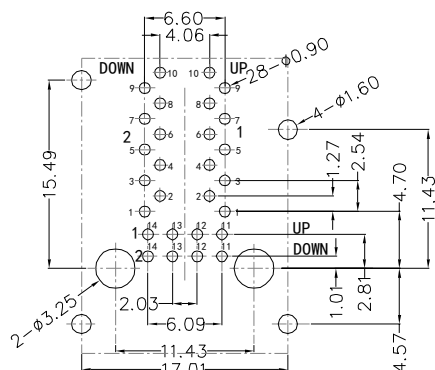

RECOMMENDED PCB LAYOUT  
VIEWED FROM COMPONENT SIDE

**MATERIAL:**

HOUSING: PBT,UL94V-0,BLACK.  
TERMINALS BRACKET: PBT,UL94V-0,BLACK.  
SHIELD: C2680,T=0.20MM,NICKEL PLATING ON ALL AREA.  
TERMINAL: PHOSPHOR BRONZE C5210,T=0.35MM,  
6U" GOLD PLATING ON CONTACT AREA.

**MECHANICAL:**

DURABILITY: 750 CYCLES MIN.  
MATING FORCE: 23N MAX.  
OPERATING TEMPERATURE: -40°C~+85°C.  
STORAGE TEMPERATURE: -40°C~+85°C.  
ALL CRITICAL DIMENSIONS WITH "\*\*\*"



苏州沃虎电子科技有限公司  
Tel:4001048018 http://www.wohu-tek.com

TITLE: RJ45 2X1 1000BASE	SIZE A4	UNITS MM[INCH]	GENERAL TOLERANCES UNLESS SPECIFIED		APPROVED BY: JP.Gong
PART NO.: SYT21Q042AB2A4D068	SCALE 1:1	REV A0	x±0.35	x°±3.0°	CHECKED BY: TW.Xu
			.x±0.30	.x°±2.0°	
REMARK:	SHEET 1/3		.xx±0.25	.xx°±1.5°	DESIGND BY: ZG.Hu
			.xxx±0.10	.xxx°±1.0°	

REACH & RoHS  
COMPLIANT

REV.	ECN / DESCRIPTION	BY	DATE
A0	NEW	ZG.Hu	2018.03.19

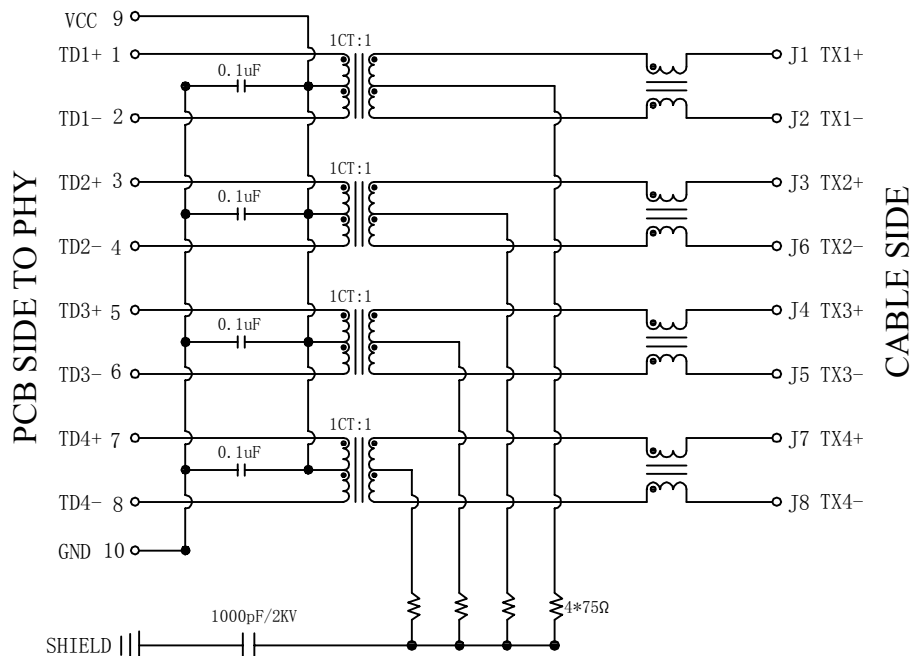

### Electrical:

- Turn ratio: 1~2: J1~J2=1CT:1CT(±2%).  
3~4: J3~J6=1CT:1CT(±2%).  
5~6: J4~J5=1CT:1CT(±2%).  
7~8: J7~J8=1CT:1CT(±2%).
- OCL: 350uH Min.at 100KHz 100mV 8mA DC.
- Insertion Loss: -1.0 dB Max 1~100MHz.
- Return loss: -18dB Min 1~30MHz;  
-14dB Min 30~60MHz.  
-12dB Min 60~80MHz.  
-10dB Min 80~100MHz.
- Cross talk: -40dB Min 1~30MHz;  
-35dB Min 30~60MHz;  
-30dB Min 60~100MHz;
- CMR: -30dB Min 1~100MHz;
- Hi-Pot: 2250V DC 6S 1mA PRI TO SEC

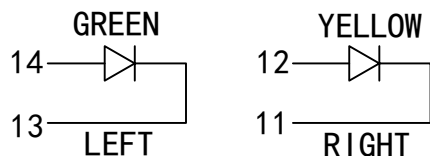

### LED Specification

Standard LED Color	LED Wavelength	Foward(A)	Foward(V)
Green	568nm	20mA	1.85-2.45V
Yellow	585nm	20mA	1.7-2.2V

**WOHU** 苏州沃虎电子科技有限公司  
Tel:4001048018 http://www.wohu-tek.com

TITLE: RJ45 2X1 1000BASE	SIZE A4	UNITS MM[INCH]	GENERAL TOLERANCES UNLESS SPECIFIED		APPROVED BY: JP.Gong
PART NO.: SYT21Q042AB2A4D068	SACLE 1:1	REV A0	x±0.35	x°±3.0°	CHECKED BY: TW.Xu
REMARK:	SHEET 2/3		.xx±0.25	.xx°±1.5°	DESIGND BY: ZG.Hu
			.xxx±0.10	.xxx°±1.0°	

REACH & RoHS  
COMPLIANT

# PROFILE OF WAVE SOLDER

REV.	ECN / DESCRIPTION	BY	DATE
A0	NEW	ZG.Hu	2018.03.19

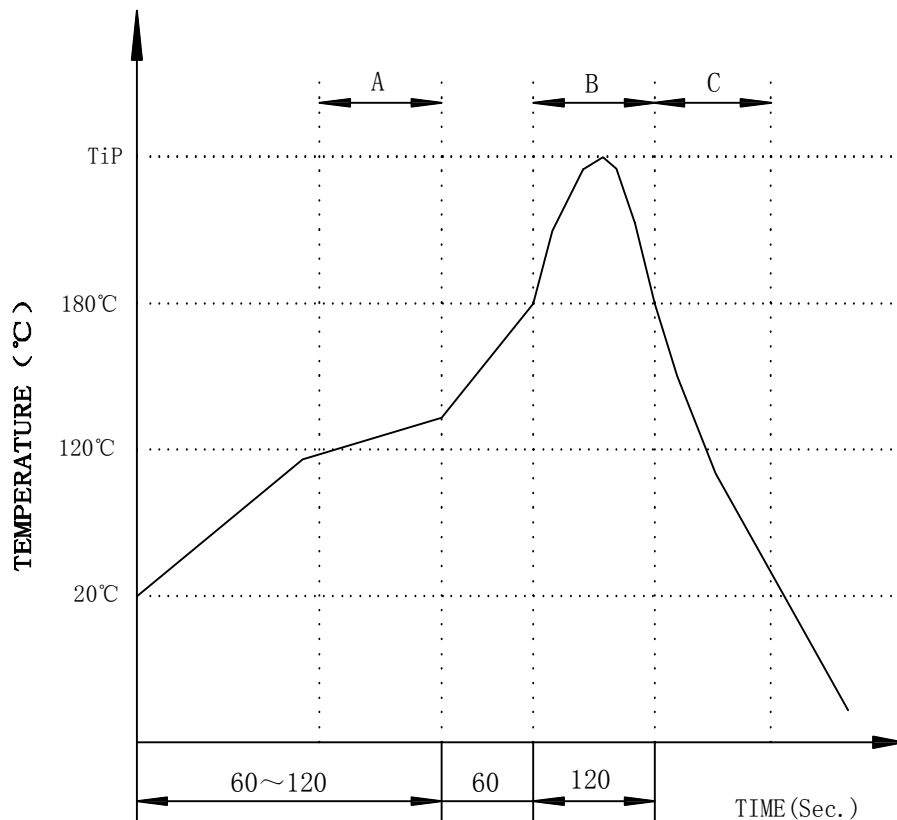

A.Preheating B.Soldering C.Gradual Cooling  
 Tip temperature:260±5°C.  
 Tip temperature time:5Sec Max.  
 Tip melting point of Sn96.5/Ag3/Cu0.5:217°C.

Remarks: after wave soldering, the plastic  
 positioning columns of the product which under the  
 PCB will be slightly melted, but it won't affect its  
 function.



苏州沃虎电子科技有限公司  
 Tel:4001048018 http://www.wohu-tek.com

TITLE: RJ45 2X1 1000BASE	SIZE A4	UNITS MM[INCH]	GENERAL TOLERANCES UNLESS SPECIFIED		APPROVED BY: JP.Gong
PART NO.: SYT21Q042AB2A4D068	SCALE 1:1	REV A0	x±0.35	x°±3.0°	CHECKED BY: TW.Xu
			.x±0.30	.x°±2.0°	
REMARK:	SHEET 3/3		.xx±0.25	.xx°±1.5°	DESIGND BY: ZG.Hu
			.xxx±0.10	.xxx°±1.0°	