

REACH & RoHS
COMPLIANT

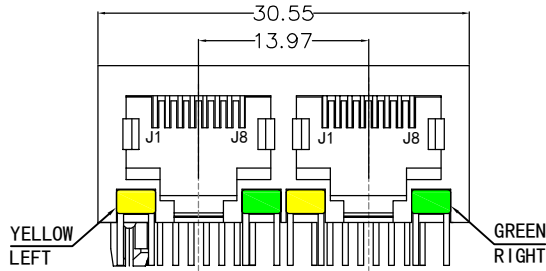

FRONT VIEW

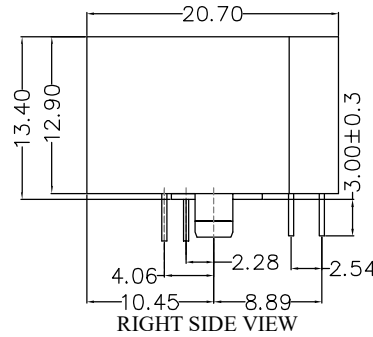

RIGHT SIDE VIEW

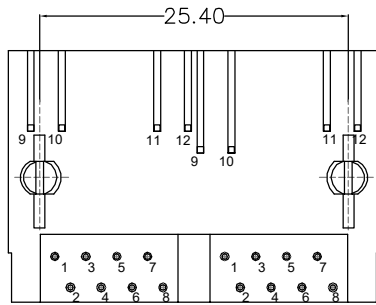

BOTTOM VIEW

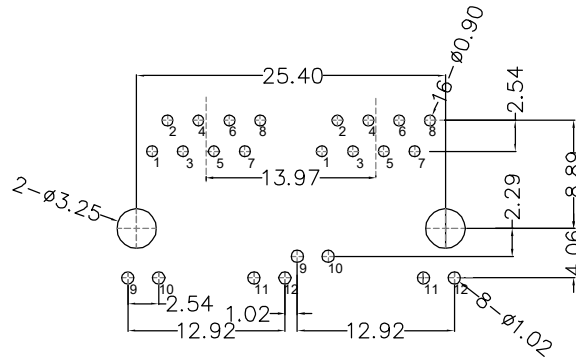

RECOMMENDED PCB LAYOUT
VIEWED FROM COMPONENT SIDE

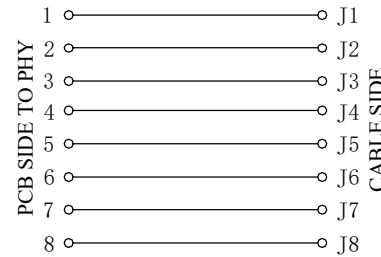
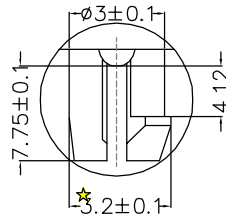

MATERIAL:

HOUSING: PBT,UL94V-0,BLACK.
TERMINAL: PHOSPHOR BRONZE Ø=0.46MM, G/FU" GOLD PLATING.
SHIELD: C2680,T=0.20MM,20 MIN NICKEL PLATING
ON ALL AREA.

MACHANICAL:

DURABILITY: 750 CYCLES MIN,12.5MM/MINUTE.
INSERTION FORCE: 2.2KG.F MAX.
RETENTION STRENGTH : 7.7KG.F BETWEEN JACK AND PLUG.
OPERATING TEMPERATURE: -40°C~+85°C.
STORAGE TEMPERATURE: -40°C~+85°C.
ALL CRITICAL DIMENSIONS WITH "**"

ELECTRICAL:

VOLTAGE: 125 VOLTS AC.
CURRENT RATING : 1.5AMP.
DIELECTRIC STRENGTH: 1000 VAC RMS 50HZ OR 60HZ,1MIN.
INSULATION RESISTANCE: 500 MEGA OHMS MIN. INITIAL
AFTER 500V DC FOR 1 MINUTE.
CONTACT RESISTANCE: SINGLE TERMINAL 30 MILLIOHMS MAX.
INITIAL 50 MILLIOHMS MAX. AFTER
DURABILITY TEST.

LED Specification

Standard LED Color	LED Wavelength	Foward(A)	Foward(V)
Green	568nm	20mA	1.8-2.8V
Yellow	585nm	20mA	1.8-2.8V

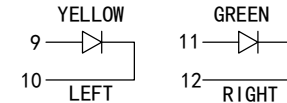

沃虎 苏州沃虎电子科技有限公司
VOOHU Su Zhou Voohu Electronic Tech.Co.Ltd

TITLE:
RJ45 1*2 带灯

SIZE
A4

UNITS
MM[INCH]

GENERAL TOLERANCES
UNLESS SPECIFIED

APPROVED BY:
Geoffrey.Song

PART NO.:
SYT59211288JB1A1DY1006

SACLE
1:1

REV
A0

$x \pm 0.35$
 $.x \pm 0.30$

CHECKED BY:
Elvis.Song

TEL: +86 400 1048 018

WEB: WWW.WOHU-TEK.COM

REMARK:

SHEET
1/4



$.xx \pm 0.25$
 $.xxx \pm 0.10$

DESIGND BY:
Sunny.Xu