

REACH & RoHS  
COMPLIANT

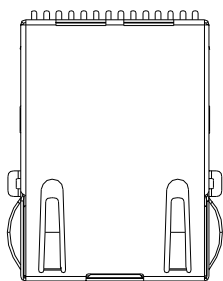

TOP VIEW

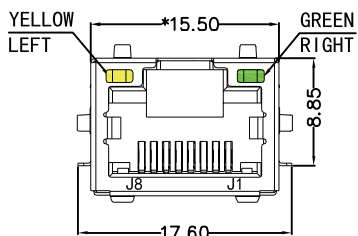

FRONT VIEW

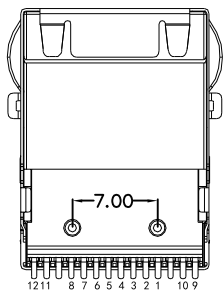

BOTTOM VIEW

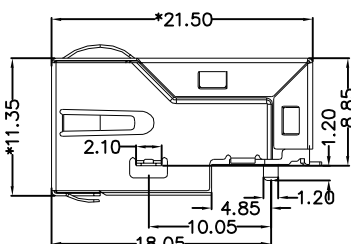

RIGHT SIDE VIEW

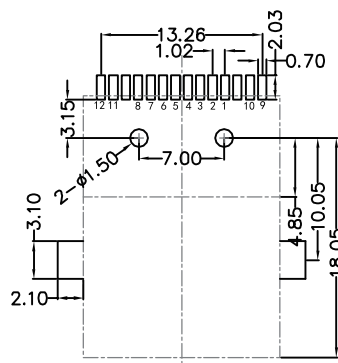

RECOMMENDED PCB LAYOUT  
VIEWED FROM COMPONENT SIDE

**MATERIAL:**

HOUSING: LCP,UL94V-0,BLACK.

TERMINALS BRACKET: LCP,UL94V-0,BLACK.

SHIELD: C2680,T=0.20MM,NICKEL PLATING ON ALL AREA.

TERMINAL: PHOSPHOR BRONZE C5191,T=0.35MM,  
6U" GOLD PLATING ON CONTACT AREA.

**MECHANICAL:**

DURABILITY: 750 CYCLES MIN.

MATING FORCE: 23N MAX.

OPERATING TEMPERATURE: -40°C~+85°C.

STORAGE TEMPERATURE: -40°C~+85°C.

ALL CRITICAL DIMENSIONS WITH "\*"

 沃虎 苏州沃虎电子科技有限公司  
VOOHU Su Zhou Voohu Electronic Tech.Co.Ltd

TITLE:  
TAB-UP 1X1 100BASE 贴片

SIZE  
A4

UNITS  
MM[INCH]

GENERAL TOLERANCES  
UNLESS SPECIFIED

APPROVED BY:  
Geoffrey.Song

PART NO.:  
SYT211B002DA1A7CBS057

SACLE  
1:1

REV  
A0

$x \pm 0.35$   $x^\circ \pm 3.0^\circ$   
 $.x \pm 0.30$   $.x^\circ \pm 2.0^\circ$

CHECKED BY:  
Elvis.Song

TEL: +86 400 1048 018

WEB: [WWW.WOHU-TEK.COM](http://WWW.WOHU-TEK.COM)

REMARK:

SHEET  
1/4

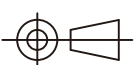

$.xx \pm 0.25$   $.xx^\circ \pm 1.5^\circ$   
 $.xxx \pm 0.10$   $.xxx^\circ \pm 1.0^\circ$

DESIGND BY:  
Sunny.Xu

REACH & RoHS  
COMPLIANT

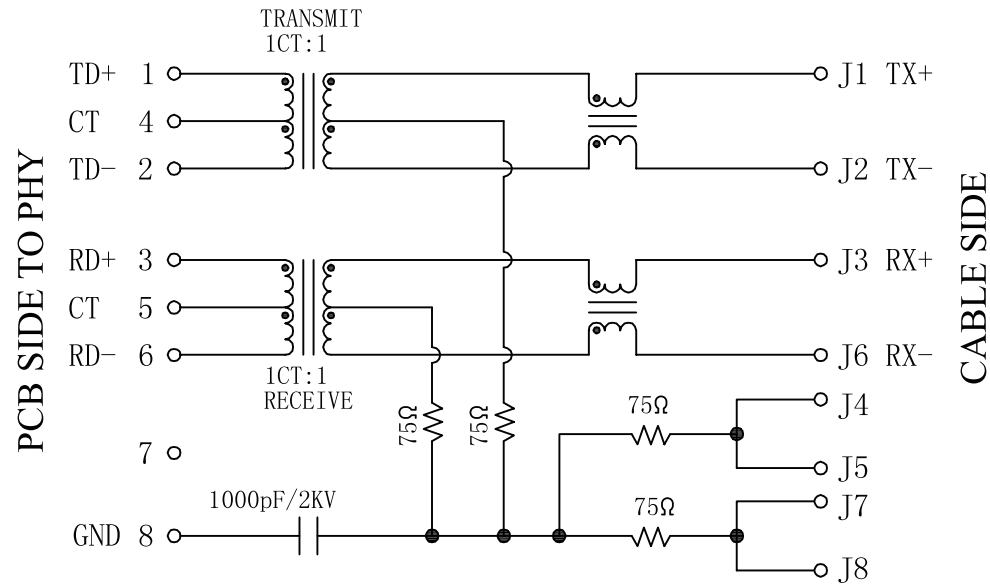

**Electrical:**

1. Turn ratio: 1~2: J1~J2=1CT:1CT(±2%).  
3~6: J3~J6=1CT:1CT(±2%).
2. OCL: 350uH Min. at 100KHz 100mV 8mA DC.
3. Insertion Loss: -1.0 dB Max 1~100MHz.
4. Return loss: -20dB Min 1~10MHz;  
-16dB Min 10~30MHz.  
-12dB Min 30~60MHz.  
-10dB Min 60~80MHz.
5. Cross talk: -40dB Min 1~30MHz;  
-35dB Min 30~60MHz;  
-30dB Min 60~100MHz;
6. CMR: -30dB Min 1~100MHz;
7. Hi-Pot: 1500V AC & 2250V DC  
6S 1mA PRI TO SEC

**LED Specification**

Standard LED Color	LED Wavelength	Foward(A)	Foward(V)
Green	568nm	20mA	1.85-2.45V
Yellow	585nm	20mA	1.7-2.2V

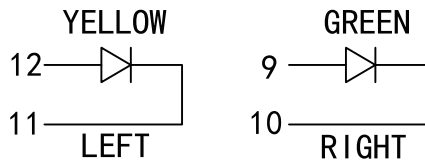

 沃虎 苏州沃虎电子科技有限公司  
VOOHU Su Zhou Voohu Electronic Tech.Co.Ltd

TITLE:  
TAB-UP 1X1 100BASE 贴片  
PART NO.:  
SYT211B002DA1A7CBS057

SIZE  
A4  
SACLE  
1:1  
SHEET  
1/4



UNITS  
MM[INCH]  
REV  
A0  
GENERAL TOLERANCES  
UNLESS SPECIFIED  
.xx±0.25  
.xxx±0.10  
x°±3.0°  
.x°±2.0°  
.xx°±1.5°  
.xxx°±1.0°

APPROVED BY:  
Geoffrey.Song  
CHECKED BY:  
Elvis.Song  
DESIGND BY:  
Sunny.Xu

TEL: +86 400 1048 018

WEB: [WWW.WOHU-TEK.COM](http://WWW.WOHU-TEK.COM)

REMARK:

REACH & RoHS  
COMPLIANT

# PROFILE OF REFLOW SOLDERING

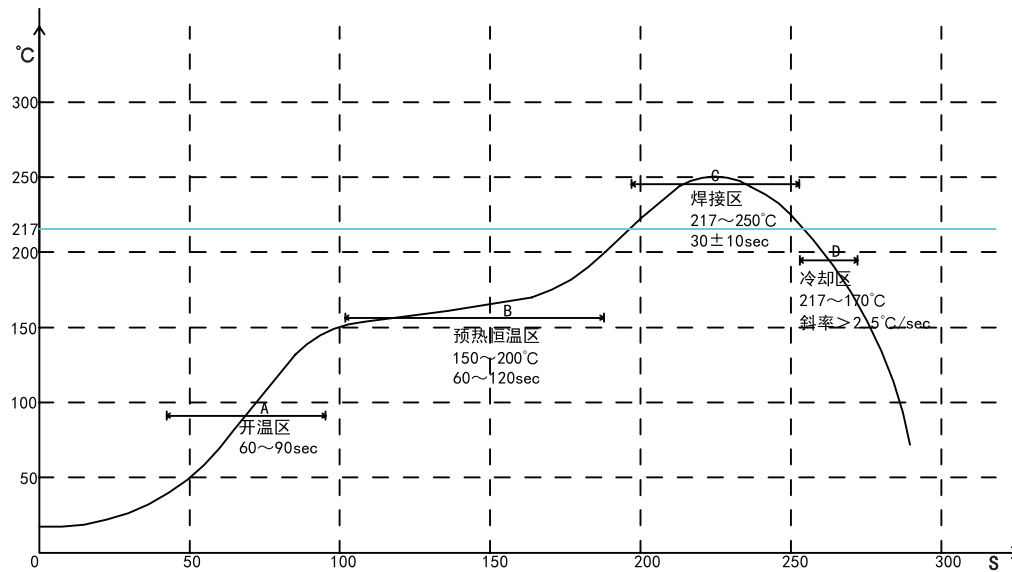

A. Temperature range of open  
 B. Preheat temperature zone  
 C. The welding zone  
 D. The cooling zone  
 Tip temperature: 265±5°C.  
 Tip temperature time: 30±10Sec.  
 Tip melting point of Sn96.5/Ag3/Cu0.5.

**沃虎** 苏州沃虎电子科技有限公司  
 VOOHU Su Zhou Voohu Electronic Tech.Co.Ltd

TEL: +86 400 1048 018

WEB: [WWW.WOHU-TEK.COM](http://WWW.WOHU-TEK.COM)

**TITLE:**  
TAB-UP 1X1 100BASE 贴片

**PART NO.:**  
SYT211B002DA1A7CBS057

**REMARK:**

**SIZE**  
A4

**UNITS**  
MM[INCH]

**SACLE**  
1:1

**REV**  
A0

**SHEET**  
1/4

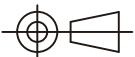

**GENERAL TOLERANCES**  
UNLESS SPECIFIED

x±0.35	x°±3.0°
.x±0.30	.x°±2.0°
.xx±0.25	.xx°±1.5°
.xxx±0.10	.xxx°±1.0°

**APPROVED BY:**  
Geoffrey.Song

**CHECKED BY:**  
Elvis.Song

**DESIGND BY:**  
Sunny.Xu