

REACH & RoHS  
COMPLIANT

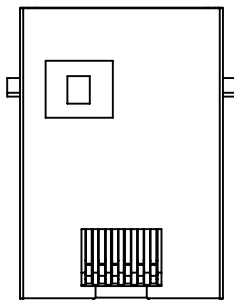

TOP VIEW

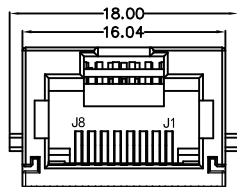

FRONT VIEW

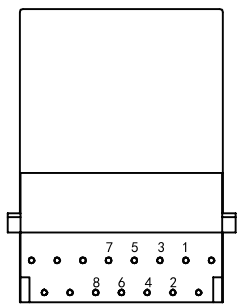

BOTTOM VIEW

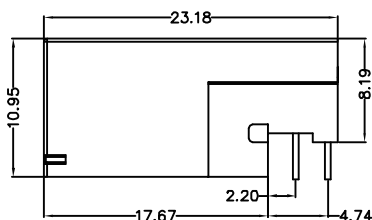

RIGHT SIDE VIEW

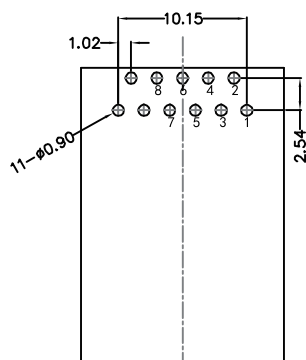

RECOMMENDED PCB LAYOUT  
VIEWED FROM COMPONENT SIDE

**MATERIAL:**

HOUSING: LCP,UL94V-0,BLACK.

TERMINALS BRACKET: LCP,UL94V-0,BLACK.

TERMINAL: PHOSPHOR BRONZE C5191,T=0.35MM,  
6U" GOLD PLATING ON CONTACT AREA.

**MECHANICAL:**

DURABILITY: 750 CYCLES MIN.

MATING FORCE: 23N MAX.

OPERATING TEMPERATURE: -40°C~+85°C.

STORAGE TEMPERATURE: -40°C~+85°C.

ALL CRITICAL DIMENSIONS WITH "\*"

 沃虎 苏州沃虎电子科技有限公司  
VOOHU Su Zhou Voohu Electronic Tech.Co.Ltd

TITLE:  
TAB-UP 1X1 100BASE 沉板

SIZE  
A4  
UNITS  
MM[INCH]

GENERAL TOLERANCES  
UNLESS SPECIFIED

APPROVED BY:  
Geoffrey.Song

PART NO.:  
SYT1511B083IWW4CBD057

SACLE  
1:1  
REV  
A0

$x \pm 0.35$	$x^\circ \pm 3.0^\circ$
$.x \pm 0.30$	$.x^\circ \pm 2.0^\circ$

CHECKED BY:  
Elvis.Song

TEL: +86 400 1048 018

WEB: [WWW.WOHU-TEK.COM](http://WWW.WOHU-TEK.COM)

REMARK:

SHEET  
1/4



$.xx \pm 0.25$	$.xx^\circ \pm 1.5^\circ$
$.xxx \pm 0.10$	$.xxx^\circ \pm 1.0^\circ$

DESIGND BY:  
Sunny.Xu

REACH & RoHS  
COMPLIANT

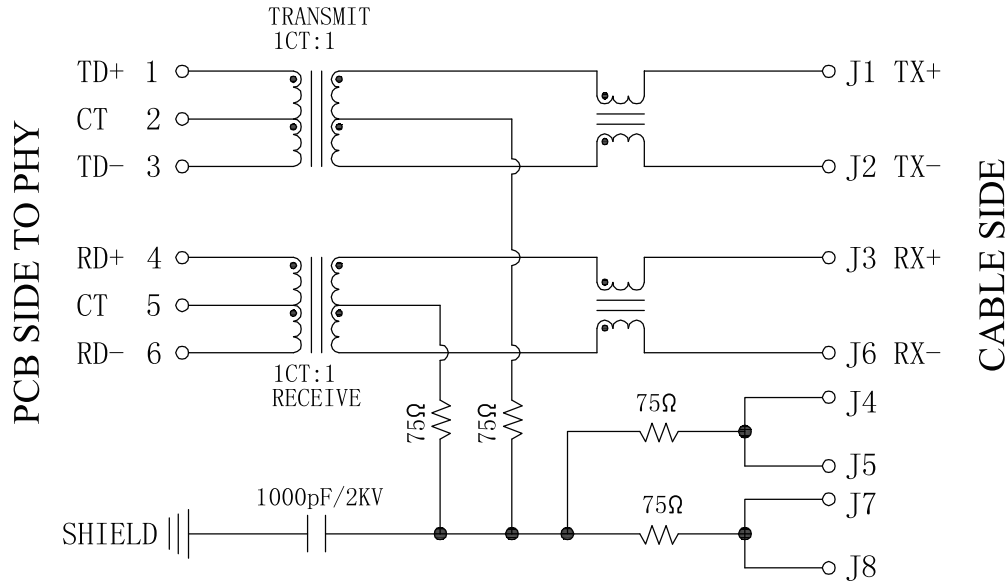

**Electrical:**

1. Turn ratio: 1~3: J1~J2=1CT:1CT(±2%).  
4~6: J3~J6=1CT:1CT(±2%).
2. OCL: 350uH Min. at 100KHz 100mV 8mA DC.
3. Insertion Loss: -1.0 dB Max 1~100MHz.
4. Return loss: -20dB Min 1~10MHz;  
-16dB Min 10~30MHz.  
-12dB Min 30~60MHz.  
-10dB Min 60~80MHz.
5. Cross talk: -40dB Min 1~30MHz;  
-35dB Min 30~60MHz;  
-30dB Min 60~100MHz;
6. CMR: -30dB Min 1~100MHz;
7. Hi-Pot: 1500V AC & 2250V DC  
6S 1mA PRI TO SEC

 沃虎 苏州沃虎电子科技有限公司  
VOOHU Su Zhou Voohu Electronic Tech.Co.Ltd

TITLE:  
TAB-UP 1X1 100BASE 沉板

SIZE  
A4

UNITS  
MM[INCH]

GENERAL TOLERANCES  
UNLESS SPECIFIED

APPROVED BY:  
Geoffrey.Song

PART NO.:  
SYT1511B083I1WW4CBD057

SACLE  
1:1

REV  
A0

x±0.35	x°±3.0°
.x±0.30	.x°±2.0°

CHECKED BY:  
Elvis.Song

TEL: +86 400 1048 018

WEB: [WWW.WOHU-TEK.COM](http://WWW.WOHU-TEK.COM)

REMARK:

SHEET  
1/4



.xx±0.25	.xx°±1.5°
.xxx±0.10	.xxx°±1.0°

DESIGN BY:  
Sunny.Xu

REACH & RoHS  
COMPLIANT

# PROFILE OF WAVE SOLDER

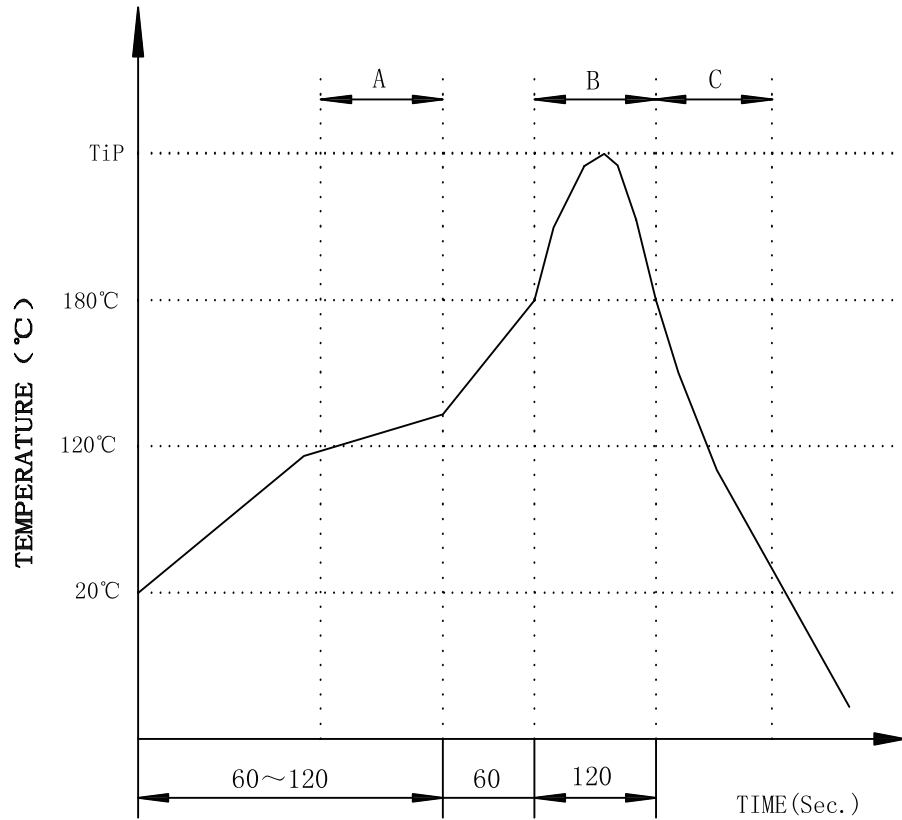

A.Preheating B.Soldering C.Gradual Cooling  
 Tip temperature:260±5°C.  
 Tip temperature time:5Sec Max.  
 Tip melting point of Sn96.5/Ag3/Cu0.5:217°C.

Remarks: after wave soldering, the plastic positioning columns  
 of the product which under the PCB will be slightly melted,  
 but it won't affect its function.

 **沃虎** 苏州沃虎电子科技有限公司  
 VOOHU Su Zhou Voohu Electronic Tech.Co.Ltd

**TITLE:**  
TAB-UP 1X1 100BASE 沉板  
**PART NO.:**  
SYT1511B083IWW4CBD057

**SIZE**  
A4  
**UNITS**  
MM[INCH]  
**SACLE**  
1:1  
**REV**  
A0  
**SHEET**  
1/4

**GENERAL TOLERANCES**  
UNLESS SPECIFIED

x±0.35	x°±3.0°
.x±0.30	.x°±2.0°
.xx±0.25	.xx°±1.5°
.xxx±0.10	.xxx°±1.0°

**APPROVED BY:**  
Geoffrey.Song  
**CHECKED BY:**  
Elvis.Song  
**DESIGND BY:**  
Sunny.Xu

TEL: +86 400 1048 018

WEB: [WWW.WOHU-TEK.COM](http://WWW.WOHU-TEK.COM)

