

A. MECHANICAL (unit:mm)

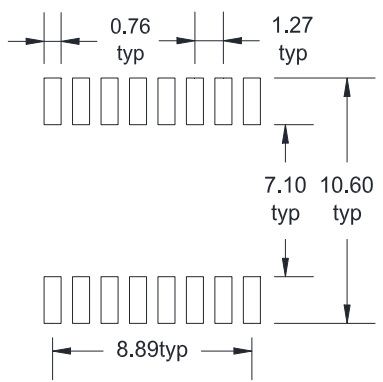

Suggested PAD Layout

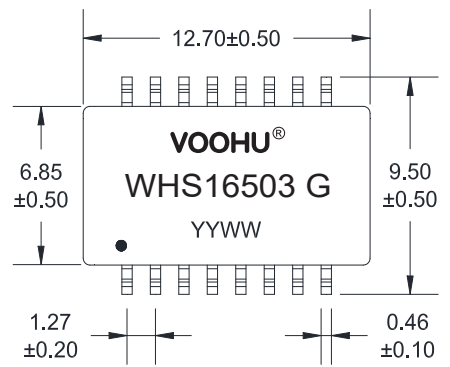
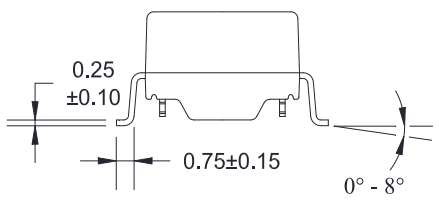
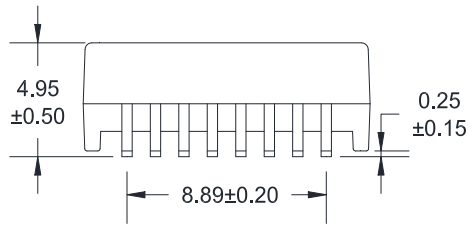

B. SCHEMATICS

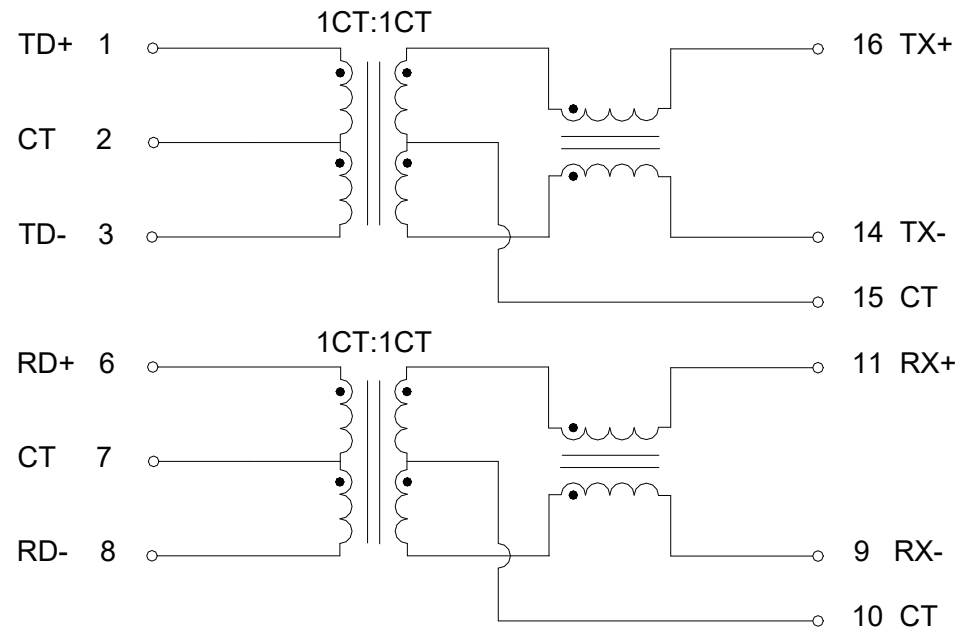

VOOHU 苏州沃虎电子科技有限公司
Su Zhou Voohu Electronic Tech.Co.Ltd

TITLE:
10/100 BASE-TX

SIZE
A4

UNITS
MM[INCH]

GENERAL TOLERANCES
UNLESS SPECIFIED

APPROVED BY:
Geoffrey.Song

PART NO.:
WHS16503 G

SACLE
1:1

REV
A0

$x \pm 0.35$	$x^\circ \pm 3.0^\circ$
$.x \pm 0.30$	$.x^\circ \pm 2.0^\circ$

CHECKED BY:
Elvis.Song

TEL: +86 400 1048 018

WEB: WWW.WOHU-TEK.COM

REMARK:

SHEET
1/3

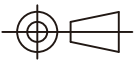

$.xx \pm 0.25$	$.xx^\circ \pm 1.5^\circ$
$.xxx \pm 0.10$	$.xxx^\circ \pm 1.0^\circ$

DESIGND BY:
Sunny.Xu

C. ELECTRICAL SPECIFICATIONS @25°C

1. OCL: 350 uH Min @ 100 KHz, 0.1V with 8mA DC BIAS
2. Leakage Inductance: 0.5uH Max @ 100KHz, 0.1V
3. DCR: 1400mΩ Max
4. Turns Ratio: 1CT:1CT±5%
5. Insertion Loss: -1.1 dB Max @ 1-100 MHz
6. Return Loss: -18 dB Min @ 1-30 MHz
 -14.4 dB Min @ 40 MHz
 -13.1 dB Min @ 50 MHz
 -12 dB Min @ 60-80 MHz
7. Cross Talk: -30 dB Min @ 1-100 MHz
8. Common Mode Rejection: -30 dB Min @ 1-100 MHz
9. Isolation Hipot: 1500VAC 1mA 60S
10. Operating temperature 0°C to +70°C
11. Storage temperature -40°C to +85°C

D. PACKAGE INFORMATION

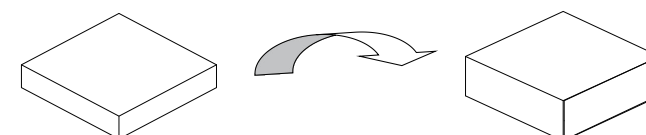
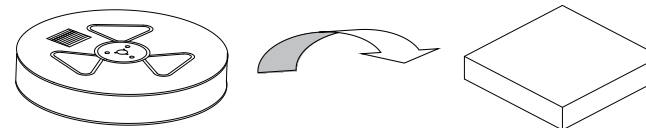
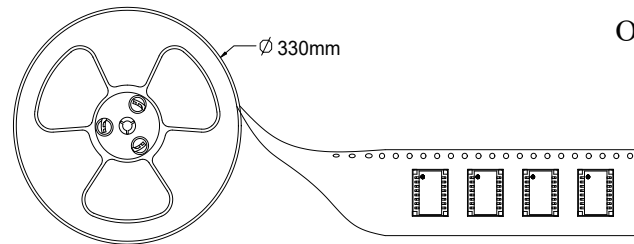
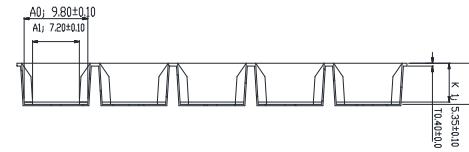
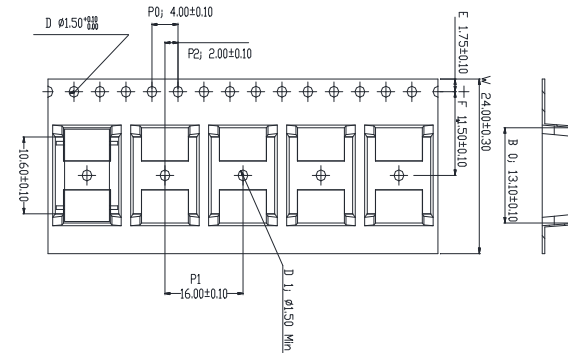

Package Quantity:
 One Reel=600Pcs
 One Inner Carton=600*3=1800Pcs
 One Export Carton=1800*2=3600Pcs

VOOHU 苏州沃虎电子科技有限公司
 Su Zhou Voohu Electronic Tech.Co.Ltd



TITLE: 10/100 BASE-TX	SIZE A4	UNITS MM[INCH]	GENERAL TOLERANCES UNLESS SPECIFIED		APPROVED BY: Geoffrey.Song
PART NO.: WHS16503 G	SACLE 1:1	REV A0	x±0.35	x°±3.0°	CHECKED BY: Elvis.Song
REMARK:	SHEET 2/3		.x±0.30	.x°±2.0°	DESIGND BY: Sunny.Xu
			.xx±0.25	.xx°±1.5°	
			.xxx±0.10	.xxx°±1.0°	

TEL: +86 400 1048 018

WEB: WWW.WOHU-TEK.COM

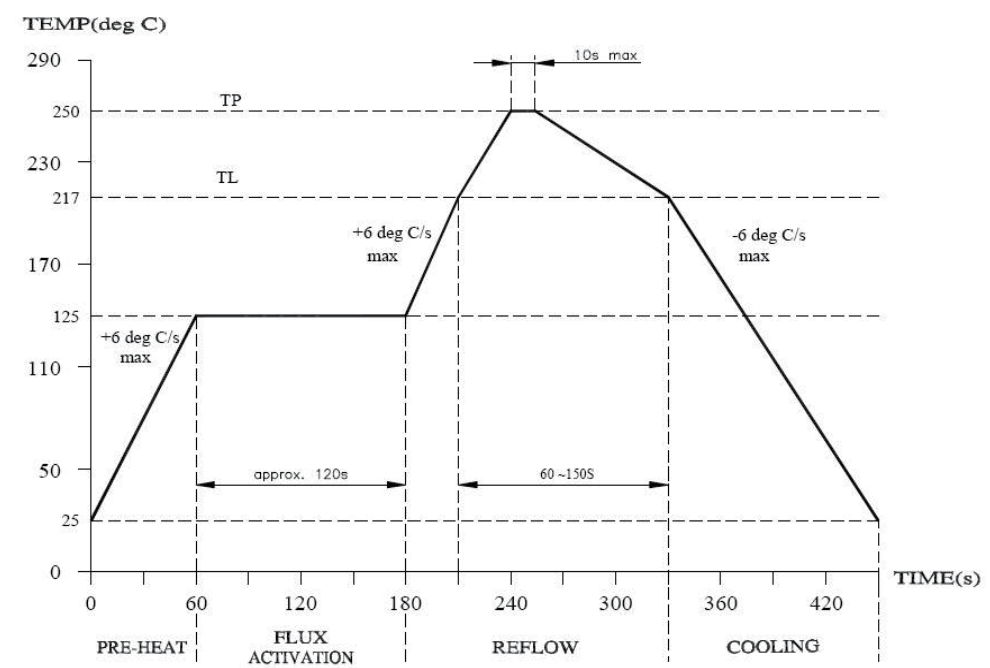
E. RECOMMEND REFLOW SOLDERING CURVE



 苏州沃虎电子科技有限公司 Su Zhou Voohu Electronic Tech.Co.Ltd	TITLE: 10/100 BASE-TX	SIZE A4	UNITS MM[INCH]	GENERAL TOLERANCES UNLESS SPECIFIED		APPROVED BY: Geoffrey.Song
	PART NO.: WHS16503 G	SACLE 1:1	REV A0	x±0.35	x°±3.0°	CHECKED BY: Elvis.Song
	REMARK:	SHEET 3/3		.xx±0.25	.xx°±1.5°	DESIGND BY: Sunny.Xu
TEL: +86 400 1048 018	WEB: WWW.WOHU-TEK.COM			.xxx±0.10	.xxx°±1.0°	