

A. MECHANICAL(unit:mm)

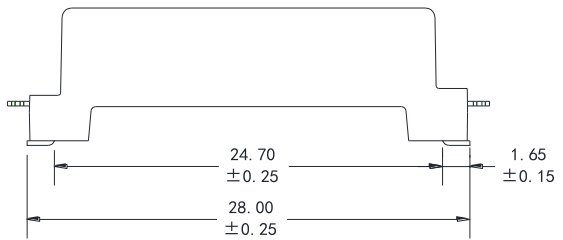

B. SCHEMATICS

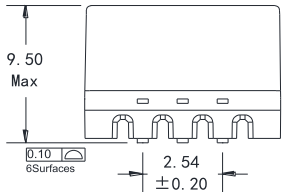
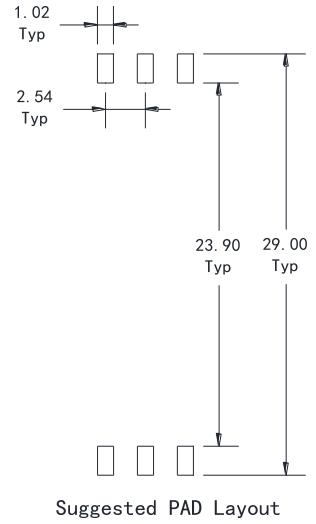
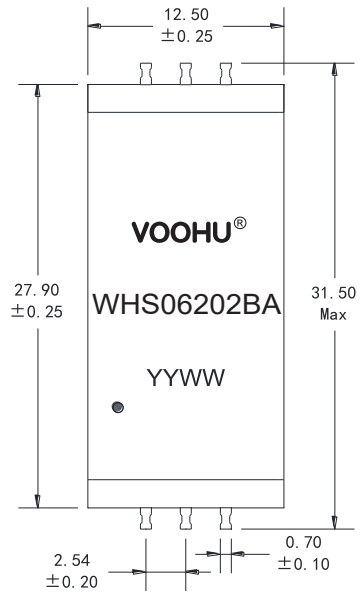
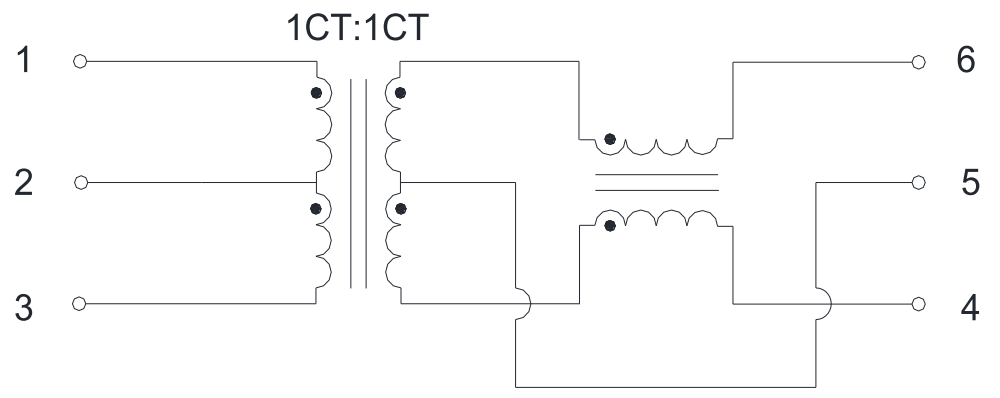

**VOOHU** 苏州沃虎电子科技有限公司  
Su Zhou Voohu Electronic Tech.Co.Ltd

TITLE:  
Transformer

PART NO.:  
WHS06202BA

REMARK:

SIZE  
A4

SACLE  
1:1

SHEET  
1/3

UNITS  
MM[INCH]

REV  
A0

GENERAL TOLERANCES  
UNLESS SPECIFIED

x±0.35	x°±3.0°
.x±0.30	.x°±2.0°
.xx±0.25	.xx°±1.5°
.xxx±0.10	.xxx°±1.0°

APPROVED BY:  
Geoffrey.Song

CHECKED BY:  
Elvis.Song

DESIGND BY:  
Sunny.Xu

TEL: +86 400 1048 018

WEB: WWW.WOHU-TEK.COM

**C. ELECTRICAL SPECIFICATIONS @25°C**

1. OCL(TD & RD): 150uH Min. @ 100 KHz, 0.1V(-40°C ~ +125°C)
2. Leakage Inductance(TD & RD, TX & RX shorted): 0.6uH Max @ 100KHz, 0.1V
3. DCR:Transformer side: 500mΩ Max  
     CM choke side: 600mΩ Max
4. Turns Ratio: 1CT:1CT±2%
5. Insertion Loss: -1.0 dB Max @ 4 MHz
6. Return Loss: -20 dB Min @ 4 MHz
7. Common Mode Rejection: -30 dB Min @ 1-100 MHz
8. Isolation Hipot: 6400VDC 1mA 60S (Equivalent to 4500VAC 1mA 60S) or 5400VAC 1mA 2s
9. Reinforced Insulation At a Working Voltage Of 1500VDC And The Creepage Distance Of 15mm Min  
     And The clearance distance Of 14mm Min
10. Operating Temperature: -40°C to +125°C
11. Storage Temperature(With Package): +10°C to +40°C
12. Storage Temperature(Without Package, Just For Components): -40°C to +125°C
13. RoHS Compliant

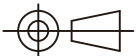
 <b>苏州沃虎电子科技有限公司</b> Su Zhou Voohu Electronic Tech.Co.Ltd	TITLE: Transformer		SIZE A4	UNITS MM[INCH]	GENERAL TOLERANCES UNLESS SPECIFIED		APPROVED BY: Geoffrey.Song	
	PART NO.: WHS06202BA		SACLE 1:1	REV A0	.xx±0.35 .x±0.30	x°±3.0° .x°±2.0°	CHECKED BY: Elvis.Song	
	REMARK:		SHEET 2/3		.xx±0.25 .xxx±0.10	.xx°±1.5° .xxx°±1.0°	DESIGND BY: Sunny.Xu	
TEL: +86 400 1048 018	WEB: <a href="http://WWW.WOHU-TEK.COM">WWW.WOHU-TEK.COM</a>							

E. MATERIAL LIST

Item	Materials	Part Name	Supplier	UL
1	Core	Mn-Zn	YST/POYEE/IDEA/ ZHENG FENG	/
		Ni-Zn		
2	WIRE	FIW6 180 Φ0.140mm	SUNTEK	E469976
		P180 Φ0.140mm	ELEKTRISOLA	E258243
		FIW6 180 Φ0.140mm	DARUN	E508179
		PFA Φ0.142mm	NEW ENGLAND	E205791
3	Case	WH-9100(胶料)	FENGQIANG-胶壳供应商 (WAH HONG-胶壳之胶原料供应商)	E150608
		Phosphor Bronze (PIN 材)	FENGQIANG-胶壳供应商 (TONGRUN-胶壳之PIN材原料供应商)	/
4	Solder	Sn96 Cu4	LICHUANG/TONGFANG/ RONKUN	/
		Sn 100		
5	Silicone	WR7306YC A	Wells Electronic Materials CO.,LTD.	E223455
		WR7306YC B		

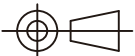
 <b>苏州沃虎电子科技有限公司</b> Su Zhou Voohu Electronic Tech.Co.Ltd	TITLE: Transformer	SIZE A4	UNITS MM[INCH]	GENERAL TOLERANCES UNLESS SPECIFIED		APPROVED BY: Geoffrey.Song
	PART NO.: WHS06202BA	SACLE 1:1	REV A0	.x±0.35	x°±3.0°	CHECKED BY: Elvis.Song
	REMARK:	SHEET 3/3		.xx±0.25	.xx°±1.5°	DESIGND BY: Sunny.Xu
TEL: +86 400 1048 018	WEB: <a href="http://WWW.WOHU-TEK.COM">WWW.WOHU-TEK.COM</a>			.xxx±0.10	.xxx°±1.0°	